



5.0" HD Video Baby Monitor



User Guide

Models: PIP1600 HD
PIP1600-2 HD
PIP1600-3 HD
PIP1600-4 HD

Safety instructions

WARNING

Strangulation Hazard. Children have STRANGLED in cords. Keep this cord out of the reach of children (more than 1 meter or 3 feet away). Do not remove the tags from the AC Adapters. Only use the AC Adapters provided.

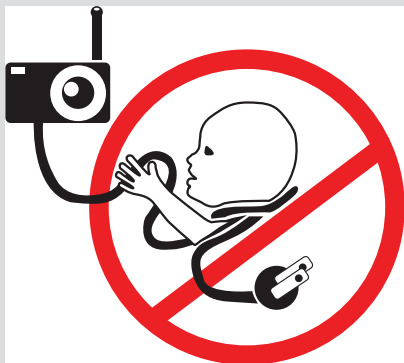

Baby monitor setup and use:

- Choose a location for the baby unit that will provide the best view of your baby in their crib.
- Place the baby unit on a flat surface, such as a dresser, desk, shelf or wall mount the unit securely with the wall mount bracket provided in the pack.
- NEVER place the baby unit or cords in the crib or within reach of the baby (the unit and cords should be more than 3 feet away).

WARNING

This Video Baby Monitor is compliant with all relevant standards regarding electromagnetic fields and is, when handled as described in the User Guide, safe to use. Therefore, always read the instructions in this User Guide carefully before using the device.

- Adult assembly is required. Keep small parts away from children when assembling.
- This product is not a toy. Do not allow children to play with it.
- This baby monitor is not a substitute for responsible adult supervision.
- Keep this User Guide for future reference.
- Do not place the baby (camera) unit or cords in the crib or within reach of the baby (the unit and cords should be more than 3 feet away).
- Keep the cords out of reach of children.
- Do not cover the baby monitor with a towel, blanket, or other item that will stop air circulation.
- Never use extension cords with power adapters. Only use the power adapters provided.
- Test this monitor and all its functions so that you are familiar with it prior to actual use.
- Do not use the baby monitor near water or allow water or other foreign substances to enter the power port or adapter.
- Do not place the Baby Monitor near a heat source.
- Only use the chargers and power adapters provided. Do not use other chargers or power adapters as this may damage the device and battery packs.
- Do not touch the plug contacts with sharp or metal objects.
- The unit should be set up and used so that parts of the user's body other than the hands are maintained at a distance of approximately 8 inches (20 cm) or more.
- The wall mounting height is less than 2 m for the baby unit.

CAUTION

There is a risk of explosion if the battery is replaced by an incorrect type. Dispose of used batteries according to the instructions.

Welcome...

to your new Video Baby Monitor!

Thank you for purchasing your new Nursery product. Now you can see and hear your baby sleeping in another room or you can monitor your older children in their playroom.

Important

To use your baby and parent units together, you must be able to establish a radio link between them, and the range will be affected by environmental conditions.

Any large metal object, like a refrigerator, a mirror, a filing cabinet, a metallic door or reinforced concrete between the baby and parent units may block the radio signal.

The signal strength may also be reduced by other solid structures, like walls, or by radio or electrical equipment, such as TVs, computers, cordless or mobile phones, fluorescent lights or dimmer switches.

Other 2.4GHz products, such as wireless networks (Wi-Fi® routers), Bluetooth™ systems, microwave ovens or other baby monitors, may cause interference with this product, so keep the baby monitor at least 5 ft (1.5 m) away from these types of products, or switch them off if they appear to be causing interference.

If the signal is weak, try moving the parent and/or the baby unit(s) to different positions in rooms.

Need help?

If you have any problems setting up or using your **PIP1600 HD**, **PIP1600-2 HD**, **PIP1600-3 HD** or **PIP1600-4 HD**, please visit us at: motorolanursery.com/support

Alternatively, you may find the answer in the 'Help' section at the back of this guide.

This User Guide provides you with all the information you need to get the most from your Video Baby Monitor.

Read the instructions carefully, and be aware that this Video Baby Monitor is only intended as an aid. It is not a substitute for responsible and proper adult supervision.

Before you use the Video Baby Monitor, set up the parent and baby units. Follow the simple instructions in 'Getting started', on the next few pages.

Important

Use only the supplied power adapter (DC5V / 1500 mA).

Got everything?

- Parent unit with built-in rechargeable Lithium-ion battery
- Baby (camera) unit
- AC power adapter for the parent unit
- AC power adapter for the baby (camera) unit
- Wall mount bracket and screws

If you have purchased multi camera pack, you will also have the following additional items:

- Baby (camera) unit(s)
- AC power adapter(s) for the baby (camera) unit(s)

1.	Getting started	7
2.	Getting to know your baby monitor	10
3.	Using the video baby monitor	14
3.1	Zoom the screen	14
3.2	Adjust the brightness on the parent unit	14
3.3	Enable audio media playback	14
3.3.1	Lullabies playback	14
3.3.2	Audio book playback	14
3.3.3	Adjust the volume level of audio playback	15
3.4	Set the timer	15
3.5	Set the temperature unit	15
3.6	Use the camera	15
3.6.1	Pair or add a camera with the parent unit	15
3.6.2	Cycle cameras	15
3.6.3	View a camera	16
3.6.4	Add a camera	16
3.6.5	Remove a camera	16
3.7	Power saving mode	16
3.8	View multiple camera on screen	17
3.9	Message inbox	17
3.10	Two-way talk	17
3.11	Default settings	17
4.	Help	21
5.	Technical Specifications	23
6.	General information	24

1. Getting started

Location

Important

Do not place your **PIP1600 HD**, **PIP1600-2 HD** , **PIP1600-3 HD** or **PIP1600-4 HD** in the bathroom or other humid areas.

Place your units within reach of the AC power outlet and wall socket. The socket-outlet should be installed near the equipment and should be easily accessible.

Setting up

Important

The baby (camera) unit must be plugged into the wall socket at all times. Use only the AC power adapter supplied with the product.

Connecting the baby (camera) unit

You will need to carry out this process for the single or multi baby (camera) units.

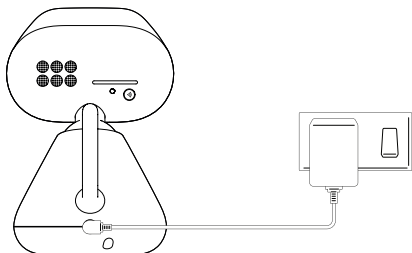

1. Plug the DC plug of the power adapter into the power socket on the rear of the baby (camera) unit and plug the other end of the AC adapter into the wall socket.
2. The baby unit turns on and the power indicator lights up in blue and blinks in red after 30 seconds if the parent unit has not been powered up.

Connecting and charging the parent unit

A rechargeable battery is already pre-installed inside the parent unit. When fully charged, you can move the parent unit without losing the link and picture from the baby (camera) unit. When charging the battery for the first time, charge for at least 16 hours continuously.

Important

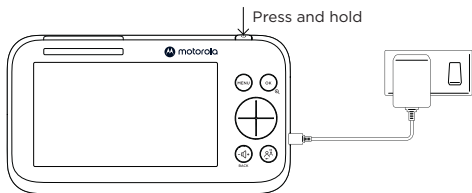

Warning! Use only the approved rechargeable Lithium-ion battery supplied with your **PIP1600 HD**, **PIP1600-2 HD**, **PIP1600-3 HD** or **PIP1600-4 HD**.



1. Plug the DC plug of the power adapter into the power socket on the side of the parent unit and plug the other end of the AC adapter into the wall socket.
2. Switch on the AC power and the parent unit will turn on or by press and hold the power button on the top side of the parent unit.

3. When the parent unit is fully charged,  will appear steadily on the screen display.
4. Press and hold the power button on the top of the parent unit to turn it on and off.

Battery low warning

If  is shown red on the display, low battery tone will be heard, please recharge the parent unit before using it again. When charging,  will scroll on the display.

Battery performance

In ideal conditions, fully charged batteries should give up to 6 hours usage time.

The charge capacity of the rechargeable battery will reduce with time as it wears out, giving the parent unit less usage / standby time. Eventually it will need to be replaced.

Batteries and the parent unit may become warm during charging. This is normal.

Note

If  is displayed on the screen, the parent and baby (camera) units are not linked to each other. Make sure that both units are powered on.

Your PIP1600 HD, PIP1600-2 HD, PIP1600-3 HD or PIP1600-4 HD is now ready for use.

2. Getting to know your baby monitor

Overview of your baby (camera) unit

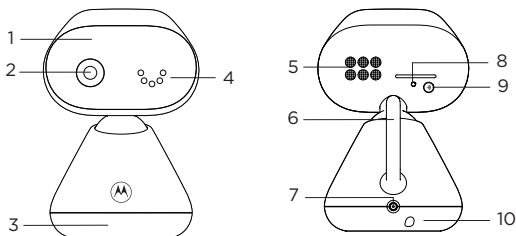

- 1. High intensity infrared LEDs behind the black lens**
Picks up clear images in the dark when the built-in photo sensor detects a low level of ambient light, the screen on the parent unit will turn black and white. The night vision icon will be displayed at the top of the LCD screen.
- 2. Camera**
- 3. Base**
- 4. Microphone**
Picks up the sound from the baby.
Note: Make sure you remove any cover or protective tape on it.
- 5. Speaker**
- 6. Antenna**
- 7. Power jack**
- 8. Power / Linking LED indicator**
Lights up in blue when the parent unit is powered on and linked to the baby (camera) unit.
- 9. Pair button**
Press and hold to pair with the parent unit.
- 10. Temperature sensor (Night vision mode)**
The temperature reading from the temperature sensor at the back of the baby unit will be displayed at the top of the LCD screen. The reading will turn RED if the temperature goes above 29°C / 84°F or below 14°C / 57°F. The reading will change to HH °C / °F if the temperature goes above 36°C / 97°F. The reading will change to LL °C / °F if the temperature goes below 1°C / 34°F.

Overview of your parent unit

Front view

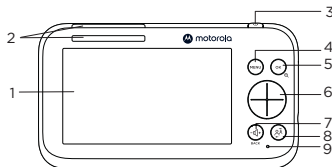



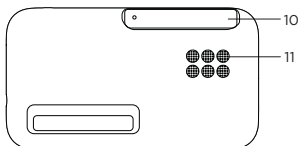





Back view















- 1. Screen display**
- 2. Dual sound level indications (front and top view)**
- 3. Power button**
Press and hold to turn on or off. Press to turn the screen on or off.
- 4. Menu button**
Press to open the menu.
- 5. OK / Zoom button**
Press to confirm a selection.
Press to do video zoom in and out during monitoring your baby.
- 6. Navigation button**
Pan or tilt the camera to different directions.
Adjust menu settings.
- 7. Volume / Back button**
During monitoring your baby, press to pop up the speaker volume bar, then scroll the navigation button to change the volume level.
- 8. Talk back button**
Press and hold to talk to the baby.
- 9. Microphone**
Picks up the sound from the parent when talking to the baby.
Note: Make sure you remove any cover or protective tape on it.
- 10. Antenna**
- 11. Speaker**

Parent unit main menu

-  Zoom in/out
-  Adjust LCD brightness
-  Play list
-  Set the alarm
-  Temperature unit °C or °F selection
-  Camera selection
-  Screen on/off timer
-  View multiple cameras
-  Message inbox

Status icons

-  Signal strength
-  Battery level indication
-  Zoom in
-  Alarm set
-  Playing lullaby
-  Playing audio book

-  Speaker off
-  Talk back
-  Night vision
-  Screen off time (5/30/60 minutes)
-  Screen saver enabled
-  Cycle view from camera

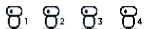
-  Camera selected

Registering the baby (camera) unit to the parent unit (Pairing)

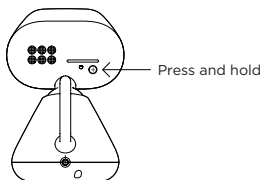

We have paired the baby unit to the parent unit in the pack. In case you want to pair an extra camera, press and hold ** on the rear of the baby (camera) unit until the voice prompt **'Ready for pairing'** is heard.

Wall mount the baby (camera) unit

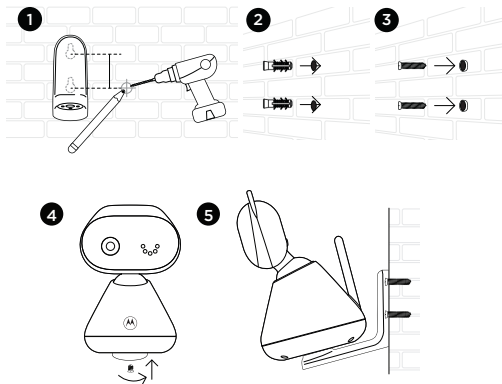

1. Mark the positions of 2 screw holes on the wall. Drill a screw hole at each marking.
2. Install the supplied wall anchors into 2 screw holes on the wall.
3. Insert the supplied wall mounting screws into the wall anchors.
4. Fix and fasten the underside of the baby (camera) unit and the wall mount bracket with the supplied separate screw.
5. Hang the wall mount bracket on the wall mounting screws on the wall.
6. Adjust the camera manually if necessary.

Note

The pack includes a power adapter with a longer cord which is beneficial for wall mount application, where your wall socket is far from the camera.

3. Using the video baby monitor

3.1 Zoom the screen

1. Press **MENU** on the the parent unit. The status bar pops up and  is selected.
2. Scroll the navigation button to select **1x** or **2x** zoom.

Note

You can also do zoom by pressing **OK** on the parent unit during monitoring your baby.



3.2 Adjust the brightness on the parent unit

1. Press **MENU** on the parent unit. The status bar pops up.
2. Scroll the navigation button to .
3. Scroll the navigation button to select the brightness level. There are 8 levels to choose from.



3.3 Enable audio media playback

You can play back pre-recorded personal or preloaded audio content (lullabies, and audio books) on the baby (camera) unit to soothe the baby. There are 10 preloaded lullabies and 10 audio books in the baby (camera) unit.



3.3.1 Lullabies playback

1. Press **MENU** on the parent unit. The status bar pops up.
2. Scroll the navigation button to .
3. Scroll the navigation button to select , then press **OK**.
4. Scroll the navigation button to select a desired lullaby or stop listening. Press **OK** to start or stop playback.

3.3.2 Audio book playback



1. Press **MENU** on the parent unit. The status bar pops up.
2. Scroll the navigation button to select .
3. Scroll the navigation button to , then press **OK**.
4. Scroll the navigation button to select a desired audio book or stop listening. Press **OK** to start or stop playback.

3.3.3 Adjust the volume level of audio playback

1. Press **MENU** on the parent unit. The status bar pops up.
2. Scroll the navigation button to .
3. Scroll the navigation button to , then press **OK**.
4. Scroll the navigation button to select a desired volume level. There are 3 levels to choose from. Then press **OK** to confirm.

3.4 Set the timer

You can set timers on the parent unit to remind you or caregivers of the time to feed the baby, change the baby's diaper or put the baby to bed.

1. Press **MENU** on the parent unit. The status bar pops up.
2. Scroll the navigation button to .
3. Scroll the navigation button to select **2h**, **4h**, **6h** or **OFF**, then press **OK**. If the next feeding time is 2 hours later, select **2h**. When activated,  will be displayed on the screen.
4. The parent unit will beep when the time limit is reached. Press **OK** to stop the timer.

3.5 Set the temperature unit

The baby (camera) unit has a temperature sensor that can detect the baby room temperature.



1. Press **MENU** on the parent unit.
2. Scroll the navigation button to .
3. Scroll the navigation button to select **°C** or **°F**, then press **OK**.

3.6 Use the camera

3.6.1 Pair or add a camera with the parent unit

See 'Registering the baby (camera) unit to the parent unit (Pairing)' on page 13.







3.6.2 Cycle cameras

1. Press **MENU** on the parent unit. The status bar pops up.
2. Scroll the navigation button to select .
3. Scroll the navigation button to select , then press **OK**.
4. If you have registered different cameras, the screen will display images from different registered cameras approximately every 12 seconds.

Note



You cannot select this option if there is only one registered camera in the parent unit.

3.6.3 View a camera



1. Press **MENU** on the parent unit. The status bar pops up.
2. Scroll the navigation button to select .
3. Scroll the navigation button to select , then press **OK**.
4. Scroll the navigation button to select a desired camera (**1 / 2 / 3 / 4**) to view the picture from that camera, then press **OK**. The selected camera  /  /  /  will appear on the screen.

If a baby (camera) unit is currently paired with the parent unit, * will appear next to the camera number (***1 / 2 / 3 / 4**).

3.6.4 Add a camera

1. Press **MENU** on the parent unit. The status bar pops up.
2. Scroll the navigation button to select .
3. Scroll the navigation button to select , then press **OK**.
4. Scroll the navigation button to select a desired camera (**1 / 2 / 3 / 4**) to add it to registration, then press **OK** to confirm.



3.6.5 Remove a camera

1. Press **MENU** on the parent unit. The status bar pops up.
2. Scroll the navigation button to select .
3. Scroll the navigation button to select , then press **OK** and **1 / 2 / 3 / 4** will pop up.
4. Scroll the navigation button to select a desired camera (**1 / 2 / 3 / 4**) to remove it from registration, then press **OK** to confirm.

Note

You cannot remove the camera if it is the only registered camera in the parent unit.

3.7 Power saving mode



1. Press **MENU** on the parent unit. The status bar pops up.
2. Scroll the navigation button to select .
3. Scroll the navigation button to select a screen off time: , **5 mins**, **30 mins** or **60 mins**, then press **OK** to confirm.
4. The screen will be off after the time limit is reached.
5. Press any button on the parent unit to wake it up.

Note

You can still hear the audio when the screen is off.

3.8 View multiple camera on screen

This function is available if you have more than one baby (camera) unit. When the split screen function is on, you can view multiple cameras on the screen and have a list of options.

1. Press **MENU** on the parent unit. The status bar pops up.
2. Scroll the navigation button to select .
 - To turn on the split screen function, scroll the navigation button to select , then press **OK** to confirm.
 - To turn off the split screen function, scroll the navigation button to select , then press **OK** to confirm.



3.9 Message inbox

It provides the information on how to download the **Motorola Nursery App**.

1. Press **MENU** on the parent unit. The status bar pops up.
2. Scroll the navigation button to select , then press **OK**. The information screen will pop up. Follow the on-screen instructions to download the app.

3.10 Two-way talk

You can use the Talk Back feature to comfort and reassure your baby. Whilst using Talk Back you will not be able to hear your baby until you release the button.

1. Press and hold  on the parent unit,  will be displayed on the screen.
2. Talk to your baby through the parent unit's microphone. Release  when you finish speaking.

3.11 Default settings

Audio playback volume level	3 levels default to middle
Screen brightness	8 levels default to middle
Temperature unit	°F for North America and °C for Europe
Lullaby	Not playing
Audio book	Not playing
Personal recording	Not playing
Timer	OFF
Power saving	5 mins
Temperature range	1 °C - 36 °C or 34 °F - 97 °F

< This page has been intentionally left blank >

< This page has been intentionally left blank >

< This page has been intentionally left blank >

4. Help

No display

- Try recharging the battery pack.
- Reset the parent and baby (camera) units. Unplug both units from the wall socket, then plug them back in.
- Check if the parent/baby (camera) unit is powered on.
- Press and hold the power button on the parent unit to switch it on.
- Make sure the correct camera is selected. Change the camera number if necessary.
- Make sure the display of the parent unit is turned on.
- The parent unit display will go blank after 5 minutes, 30 minutes or 60 minutes to save power (depending on video settings).

No sound or the audio level is low.

- Make sure that the protective tapes on the parent and baby (camera) units are removed.
- Adjust the speaker volume level according to the instructions described in the user guide.

The baby (camera) unit has lost its link with the parent unit.

- The baby (camera) unit is too far away and may be out of range. Move it closer to the parent unit.
- Disconnect both the parent and baby (camera) units from the power outlet. Wait for about 15 seconds and reconnect them. Allow up to one minute for the parent and baby (camera) units to synchronize.
- Re-register your baby (camera) unit if necessary, see page 13.

Noise interference on your parent unit

- Make sure there is at least 3 to 6 feet between the parent and baby (camera) units to avoid audio feedback.
- The baby (camera) unit is too far away and may be out of range. Move it closer to the parent unit.
- Make sure the parent and baby (camera) units are not placed near other electrical equipment, such as a television, computer or cordless/mobile telephone. Move the parent and baby (camera) units 5 feet away from other electrical equipment.
- Use of other 2.4 GHz products, such as wireless networks (Wi-Fi® routers), Bluetooth™ systems, or microwave ovens, may cause interference with this product.
- If the signal is weak, try moving the parent and/or baby (camera) units to different positions in rooms.

Noise interference on your device

- To avoid background noise or echoes, ensure there is enough distance between your device and the camera (baby unit).
- Use of other 2.4 GHz products, such as wireless networks (Wi-Fi® routers), Bluetooth™ systems, or microwave ovens, may cause interference with this product. Keep the parent and baby (camera) units at least 5 feet away from these types of products, or switch them off if they appear to be causing interference.

5. Technical Specifications

RF frequency bands	2400 MHz to 2483.5 MHz
Parent unit display	5.0" diagonal 720p TFT LCD
Operating range	0 °C - 40 °C or 32 °F - 104 °F
Baby unit Image sensor	Color CMOS 2M Pixels
Power adapter for the baby and parent units	Input: 100-240V AC, 50/60Hz, 300mA or 400mA; Output: 5.0V DC, 1500mA
Parent unit battery information	Amperex Technology Limited 3.8V, 2800mAh Lithium-Ion Polymer rechargeable battery pack
Battery life	6 hours (maximum)

WARNING

Use only with provided power adapter:

Dongguan Becky Electronics Tech Co., Ltd. (BQ12G-0501500-U)

Input 100-240V AC, 50/60Hz, 400mA;

Output: 5.0V DC, 1500mA

or

Mass Power Electronic Limited. (S012-1B050150VU)

Input: 100-240V AC, 50/60Hz, 300mA;

Output: 5.0V DC, 1500mA

WARNING

Do not attempt to replace the battery, but contact customer service if it needs replacing.

Note

Specifications are subject to change without prior notice.

6. General information

Cleaning and care

Important

Always switch off and disconnect the power adapter before cleaning your video baby monitor.

- Clean your video baby monitor with a slightly damp cloth or with an anti-static cloth. Never use cleaning agents or abrasive solvents.
- Do not clean any part of the video baby monitor with thinners or other solvents and chemicals - this may cause permanent damage to the product which is not covered by the warranty.
- Keep your video baby monitor away from hot, humid areas or strong sunlight, and do not let it get wet.
- Every effort has been made to ensure high standards of reliability of your Video Baby Monitor. However, if something does go wrong, please do not try to repair it yourself - contact Customer Service for assistance.

Product Disposal Instructions

Product disposal instructions for residential users

When you have no further use for it, please remove any batteries and dispose of them and the product according to your local authority's recycling processes. For more information, please contact your local authority or the retailer where the product was purchased.



Product disposal instructions for business users

Business users should contact their suppliers and check the terms and conditions of the purchase contract and ensure that this product is not mixed with other commercial waste for disposal.



Consumer Products and Accessories Warranty

Thank you for purchasing this Motorola branded product manufactured under license by Meizhou Guo Wei Electronics Co. LTD., AD1 section, The economy exploitation area, Meizhou, Guangdong, P.R.China . ("MZGW").

What Does this Warranty Cover?

Subject to the exclusions contained below, MZGW warrants that this Motorola branded product ("Product") or certified accessory ("Accessory") sold for use with this product that it manufactured to be free from defects in materials and workmanship under normal consumer usage for the period outlined below. This Limited Warranty is your exclusive warranty and is not transferable.

Who is covered?

This warranty extends only to the first consumer purchaser, and is not transferable.

What will MZGW do?

MZGW or its authorized distributor at its option and within a commercially reasonable time, will at no charge repair or replace any Products or Accessories that do not conform to this limited warranty. We may use functionally equivalent reconditioned / refurbished / pre-owned or new Products, Accessories or parts.

What Other Limitations Are There?

ANY IMPLIED WARRANTIES, INCLUDING WITHOUT LIMITATION THE IMPLIED WARRANTIES OF MERCHANTABILITY AND FITNESS FOR A PARTICULAR PURPOSE, SHALL BE LIMITED TO THE DURATION OF THIS LIMITED WARRANTY, OTHERWISE THE REPAIR OR REPLACEMENT PROVIDED UNDER THIS EXPRESS LIMITED WARRANTY IS THE EXCLUSIVE REMEDY OF THE CONSUMER, AND IS PROVIDED IN LIEU OF ALL OTHER WARRANTIES, EXPRESS OF IMPLIED. IN NO EVENT SHALL MOTOROLA OR MZGW BE LIABLE, WHETHER IN CONTRACT OR TORT (INCLUDING NEGLIGENCE) FOR DAMAGES IN EXCESS OF THE PURCHASE PRICE OF THE PRODUCT OR ACCESSORY, OR FOR ANY INDIRECT, INCIDENTAL, SPECIAL OR CONSEQUENTIAL DAMAGES OF ANY KIND, OR LOSS OF REVENUE OR PROFITS, LOSS OF BUSINESS, LOSS OF INFORMATION OR OTHER FINANCIAL LOSS ARISING OUT OF OR IN CONNECTION WITH THE ABILITY OR INABILITY TO USE THE PRODUCTS OR ACCESSORIES TO THE FULL EXTENT THESE DAMAGES MAY BE DISCLAIMED BY LAW.

Some jurisdictions do not allow the limitation or exclusion of incidental or consequential damages, or limitation on the length of an implied warranty, so the above limitations or exclusions may not apply to you. This warranty gives you specific legal rights, and you may also have other rights that vary from one jurisdiction to another.

Products Covered	Length of Coverage
Consumer Products	Two (2) years from the date of the products original purchase by the first consumer purchaser of the product.
Consumer Accessories (battery, power supply(s) and line cords)	Ninety (90) days from the date of the accessories original purchase by the first consumer purchaser of the product.
Consumer Products and Accessories that are Repaired or Replaced	The balance of the original warranty or for ninety (90) days from the date returned to the consumer, whichever is longer.

Exclusions

Normal Wear and Tear. Periodic maintenance, repair and replacement of parts due to normal wear and tear are excluded from coverage.

Batteries. Only batteries whose fully charged capacity falls below 80% of their rated capacity and batteries that leak are covered by this limited warranty.

Abuse & Misuse. Defects or damage that result from: (a) improper operation, storage, misuse or abuse, accident or neglect, such as physical damage (cracks, scratches, etc.) to the surface of the product resulting from misuse; (b) contact with liquid, water, rain, extreme humidity or heavy perspiration, sand, dirt or the like, extreme heat, or food; (c) use of the Products or Accessories for commercial purposes or subjecting the Product or Accessory to abnormal usage or conditions; or (d) other acts which are not the fault of Motorola or MZGW are excluded from coverage.

Use of Non-Motorola branded Products and Accessories. Defects or damage that result from the use of Non-Motorola branded or certified Products or Accessories or other peripheral equipment are excluded from coverage.

Unauthorized Service or Modification. Defects or damages resulting from service, testing, adjustment, installation, maintenance, alteration, or modification in any way by someone other than Motorola, MZGW or its authorized service centers, are excluded from coverage.

Altered Products. Products or Accessories with (a) serial numbers or date tags that have been removed, altered or obliterated; (b) broken seals or that show evidence of tampering; (c) mismatched board serial numbers; or (d) nonconforming or non-Motorola branded housings, or parts, are excluded from coverage.

Communication Services. Defects, damages, or the failure of Products or Accessories due to any communication service or signal you may subscribe to or use with the Products or Accessories is excluded from coverage.

How to Obtain Warranty Service or Other Information?

To obtain service or information, please visit us at:
motorolanursery.com/support

You will receive instructions on how to ship the Products or Accessories at your expense and risk, to a MZGW Authorized Repair Center.

To obtain service, you must include: (a) the Product or Accessory; (b) the original proof of purchase (receipt) which includes the date, place and seller of the Product; (c) if a warranty card was included in your box, a completed warranty card showing the serial number of the Product; (d) a written description of the problem; and, most importantly; (e) your address and telephone number.

EU Declaration of Conformity (DoC)

Hereby, Meizhou Guo Wei Electronics Co. LTD declares that the product is in compliance with RE Directive 2014/53/EU. The full text of the EU declaration of conformity is available on the website: motorolanursery.com.

FCC and IC regulations

FCC Caution:

Any changes or modifications not expressly approved by the party responsible for compliance could void the user's authority to operate the equipment.

This device complies with part 15 of the FCC Rules. Operation is subject to the following two conditions: (1) This device may not cause harmful interference, and (2) this device must accept any interference received, including interference that may cause undesired operation.

IMPORTANT NOTE:

Note: This equipment has been tested and found to comply with the limits for a Class B digital device, pursuant to part 15 of the FCC Rules. These limits are designed to provide reasonable protection against harmful interference in a residential installation. This equipment generates, uses and can radiate radio frequency energy and, if not installed and used in accordance with the instructions, may cause harmful interference to radio communications. However, there is no guarantee that interference will not occur in a particular installation. If this equipment does cause harmful interference to radio or television reception, which can be determined by turning the equipment off and on, the user is encouraged to try to correct the interference by one or more of the following measures:

- Reorient or relocate the receiving antenna.
- Increase the separation between the equipment and receiver.
- Connect the equipment into an outlet on a circuit different from that to which the receiver is connected.
- Consult the dealer or an experienced radio/TV technician for help.

ISED Warning

This device complies with Innovation, Science, and Economic Development Canada licence-exempt RSS standard(s). Operation is subject to the following two conditions:

- (1) this device may not cause interference, and
- (2) this device must accept any interference, including interference that may cause undesired operation of the device.

Le présent appareil est conforme aux CNR d'Innovation, Sciences et Développement économique Canada applicables aux appareils radio exempts de licence. L'exploitation est autorisée aux deux conditions suivantes :

- (1) l'appareil ne doit pas produire de brouillage, et
- (2) l'utilisateur de l'appareil doit accepter tout brouillage radioélectrique subi, même si le brouillage est susceptible d'en compromettre le fonctionnement.

Radiation Exposure Statement:

The baby unit complies with FCC/ISED radiation exposure limits set forth for an uncontrolled environment. The baby unit should be installed and operated with minimum distance 20cm between the radiator & your body. The parent unit has been tested and comply with FCC and ISED SAR limits.

Déclaration d'exposition aux radiations:

L'unité bébé est conforme aux limites d'exposition aux rayonnements FCC / ISED établies pour un environnement non contrôlé. L'unité bébé doit être installée et utilisée avec une distance minimale de 20 cm entre le radiateur et votre corps.

L'unité parent a été testée et est conforme aux limites SAR FCC et ISED.

Manufactured, distributed or sold by Meizhou Guo Wei Electronics Co. LTD., official licensee for this product. MOTOROLA and the Stylized M Logo are trademarks or registered trademarks of Motorola Trademark Holdings, LLC. and are used under license. All other trademarks are the property of their respective owners. © 2022 Motorola Mobility LLC. All rights reserved.

Version 1.0 (EN-EU&US)

